

# Manual Builder Extreme 1000/1500/2000 PRO

*For the machines built after*

*serial number XXXX.XXX.19.0063 with touchscreen interface*

*Software version v1.0 and up*



# Manual Builder Extreme 1000/1500/2000 PRO

## Index

Introduction.....	3
Warranty .....	4
Safety warnings .....	5
Quickstart .....	9
Accessories .....	11
Installing the machine.....	12
Level the printer .....	12
Extreme 1500 wheels.....	13
Connecting Battery pack .....	13
Bed leveling .....	13
Dual Printhead .....	17
Filament detection.....	21
Start Printing .....	22
G-code/slicing.....	23
Maintenance .....	26
Maintenance schedule .....	26
Trouble shooting.....	27
Dual print head maintenance .....	28
Attachment.....	29
Technical specifications.....	29
User Interface .....	30
Homescreen.....	31
Select file: .....	33
Settings:.....	34
Settings windows: .....	35
Material: .....	36
Network:.....	37
Tune Menu: .....	39
License:.....	40
Machine Notifications: .....	42
Machine drawings.....	44

# Manual Builder Extreme 1000/1500/2000 PRO

## Introduction

Thank you for buying the Builder Extreme. This high-quality, industrial 3D printer will allow you to build your prototypes and one-of-a-kind models in the quickest and cheapest possible way.

Be sure to only use the print materials approved by Builder. If you experience any problems or need advice on material choice, please contact your local reseller or [helpdesk@builder3dprinters.com](mailto:helpdesk@builder3dprinters.com).

This manual will help you:

- Install your Extreme correctly;
- Carry out preventive maintenance;
- Perform trouble shooting;
- Perform minor repairs;
- Get the most out of your machine.

We advise to start with smaller, simple objects and gradually proceed to printing more complex geometries.

## Manual Builder Extreme 1000/1500/2000 PRO

### Warranty

The Builder Extreme 3D printer is warranted to the original purchaser for a period of 1 year. The extruder head is warranted to the original purchaser for a period of 3 months from the original purchase date, only when the 3D printer is used with filament approved and delivered by Builder 3D Printers. The repair has to be carried out by Builder 3D Printers.

The warranty of the Builder 3D Printer will expire when the machine is:

- Damaged;
- Neglected;
- Immersed in water;
- Abused;
- Installed improperly;
- Disassembled;
- Serviced improperly.

If you experience any problems with your Extreme, please visit our YouTube channel which provides you with service videos that might help solve the issue.

<http://www.youtube.com/user/builder3dprinters>

## Manual Builder Extreme 1000/1500/2000 PRO

### Safety warnings

**Please** take a few minutes to read the **safety warnings**. Also read the present manual, which helps you install your Builder Extreme and use it the way it is intended. This manual is setup in a way that it can be used for more than one model, so it applies to Extreme 1000 PRO, 1500 PRO and 2000 PRO. When there are differences between the models, this document will explain them for each type.

If you have any questions, please contact your local reseller or [helpdesk@builder3dprinters.com](mailto:helpdesk@builder3dprinters.com)

# Manual Builder Extreme 1000/1500/2000 PRO

## Safety Warnings (please read warnings before use)

- Before using the Builder Extreme, read all the warnings and manuals.

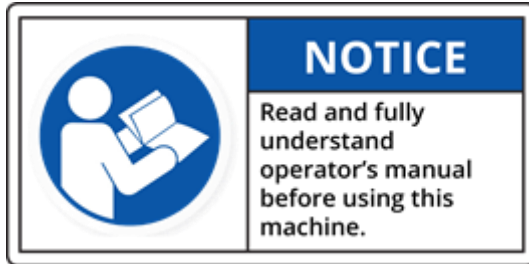

- Let only well trained personnel use this machine. Well trained personnel has experience with 3D printing and 3D printing machines. Builder 3D Printers can provide a training so machine and personnel have the skills to operate the Extreme. Please contact your local reseller or [helpdesk@builder3dprinters.com](mailto:helpdesk@builder3dprinters.com)
- Place the Builder Extreme on a concrete floor and set it level, so that the machine stands stable.
- Install the Builder Extreme in a room with sufficient ventilation.



- **DANGER!** Do not open the electronics cabinet (access only by authorized personnel). Risk of electric shock which may result in serious injury or death!

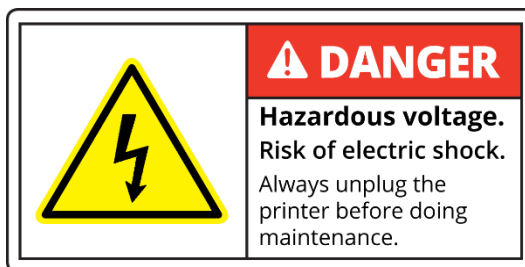

- **WARNING!** Before performing maintenance on the Builder Extreme or before making any adjustments to the machine, disable it by engaging the power off button. Beware! The print head and build plate can still be very hot!

**Manual Builder Extreme 1000/1500/2000 PRO**

- **WARNING!** When the heater is on, the extruder (a nozzle, brass piece) is very hot!



- **WARNING!** When you want to replace the filament on top of the machine use safe work stairs.
- **WARNING!** Do not use flammable liquids inside or outside the Builder Extreme. If you want to clean the build plate **turn off** the power first, then you can clean the aluminium plate with a wet towel. When the build plate is dry, you can turn on the power.
- **WARNING!** Maintenance of the electrical and mechanical components can only be done by authorized personnel.
- **WARNING!** Do not lean in or step into the Builder Extreme.



- Do not use the machine for purposes other than printing parts.
- When the Builder Extreme is in operation, keep the doors of the machine closed.

## Manual Builder Extreme 1000/1500/2000 PRO

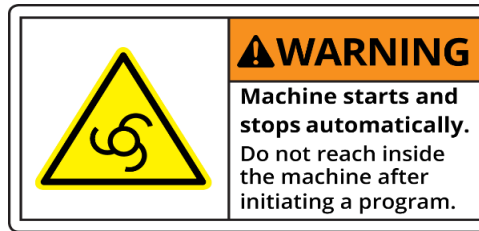

- Use only Builder 3D Printers certified materials.
- **WARNING!** Turn off the power and wait for 15 minutes when you want to replace the extruder head. Be careful, this part is HOT!



- When the machine is operated 24/7, mount a working fire or smoke detector in the room where the Builder Extreme is installed.

If you are not sure what to do, contact the helpdesk.

[helpdesk@builder3dprinters.com](mailto:helpdesk@builder3dprinters.com)



# Manual Builder Extreme 1000/1500/2000 PRO

## Quickstart

### Unbox the Builder Extreme

Please watch the unboxing video which shows how to remove the box and take the Extreme down from the pallet. Note that the Builder Extreme **MUST** be removed from the pallet and placed on a concrete, stable floor at all times. [See instruction video online.](#)

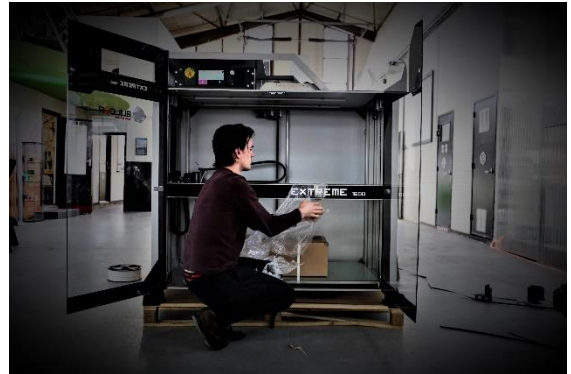

### Level the Extreme

Use the 2 levels supplied with the machine to make sure it is levelled before use. Use the level tools on the front, left and right. Note that you do not need to level the print bed or print head frame, you need to level the machine itself. Put the levels on the bottom plate of the machine. The print bed was already levelled in our factory.

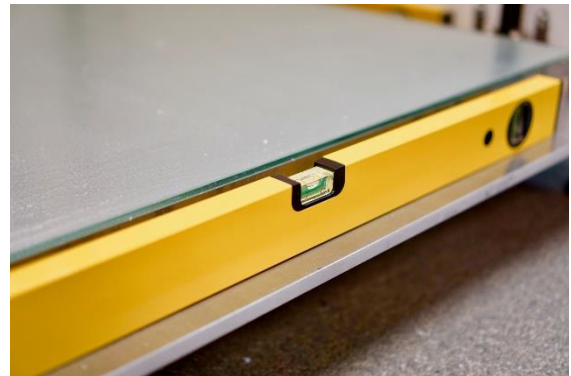

### Switch on the battery pack

The switch is located behind the filament spool holders. In Extreme 1000 PRO and 1500 PRO it is underneath the top plate of the machine, in Extreme 2000 PRO – in the top drawer

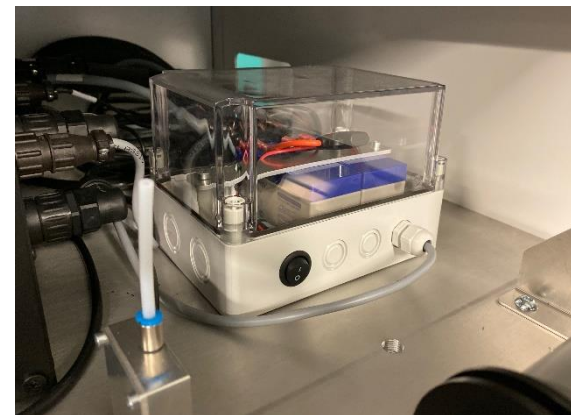

### Install filaments

Pre-heat the extruder. Insert filament into both extruders. Note that the Dual-Feed extruder needs to be filled with both filaments all the time, even when you print in 1 color. This prevents the Dual-Feed extruder from clogging. See instruction video online.

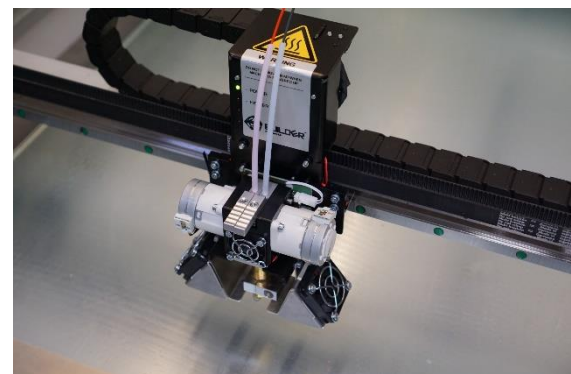

## Manual Builder Extreme 1000/1500/2000 PRO

### Surface test

The build plate has been levelled in the factory, but it is important to check if this is still the case after transport and installation. Start printing the surface test from the internal memory of the machine. The surface test (0.4 mm nozzle) shows you if the build plate is still levelled. Be aware that the surface test must be printed with 2 filaments

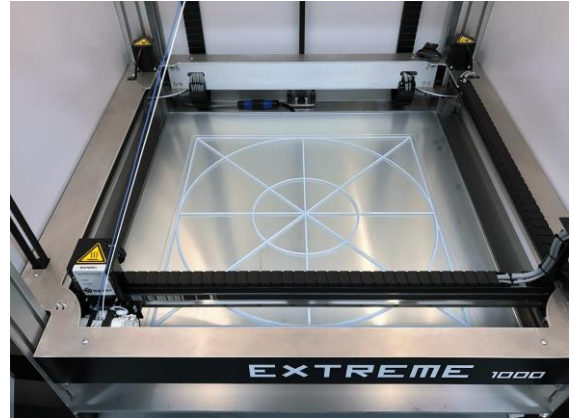

### Bed level (only if needed)

If the surface test does not come out right, i.e. evenly on the whole surface of the build plate, it can mean two things: the nozzle is too far or too close to the build plate. There are 3 points enabling you to adjust the position of the frame. Gently turn the screws clockwise if the nozzle is too close to the plate and counter-clockwise if the nozzle is too far from the plate. Do maximum half- turn on each point at the time. Perform "auto home" and start the surface test again.

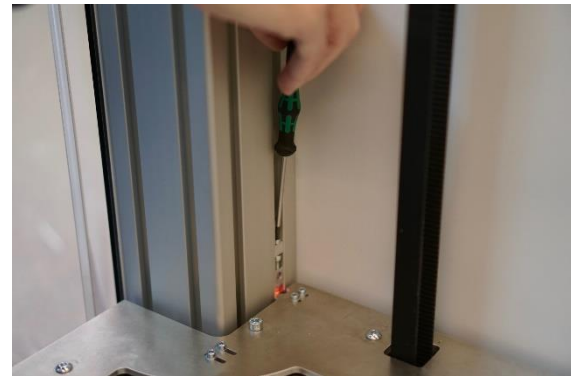

### Print with BOTH extruders when not printing dual colored objects

For the best quality of prints and to ensure the lifetime of the Dual-Feed extruder, we advise you to print with both extruder motors all the time. How? Start your print and as soon as the extruder and print bed heated up and the print head started moving, go to Tune, Flow and change the ratio to 50:50. Now both motors will be used. This also allows you to print 9 kg filament without having to stop your print and changing filaments.

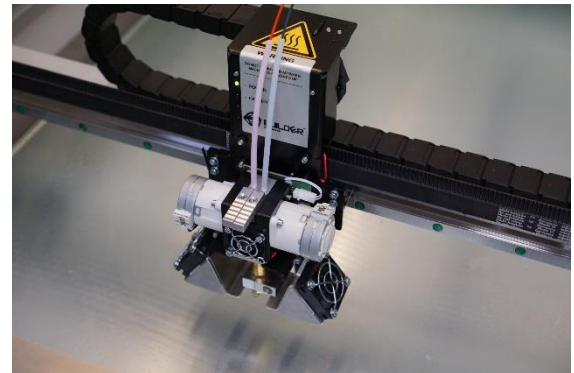

### Remove print from the build plate

After the print has finished, open the doors of the Extreme and let the build plate cool down to room temperature. This makes it easier for you to remove the object from the plate.

If you have any questions about the installation, please contact your local reseller or [helpdesk@builder3dprinters.com](mailto:helpdesk@builder3dprinters.com)

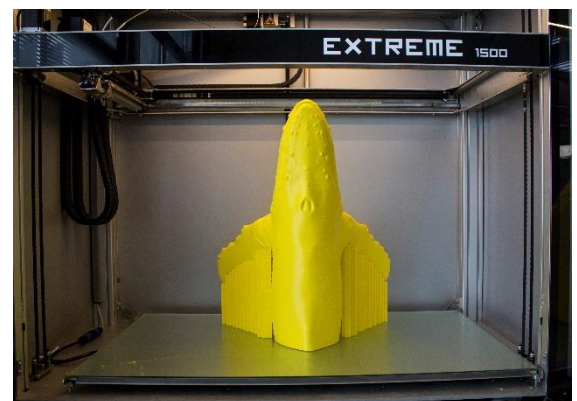

# Manual Builder Extreme 1000/1500/2000 PRO

## Accessories

The Builder Extreme comes with the following accessories:

Extreme 1000 PRO	Extreme 1500 PRO	Extreme 2000 PRO
<ul style="list-style-type: none"><li>• Paint roller set;</li><li>• Level 60cm 2x;</li><li>• Wood glue;</li><li>• Heater block tool;</li><li>• Nozzle tool;</li><li>• Allenkey 2.5mm;</li><li>• Nozzle 0.8mm;</li><li>• Nozzle 1.2mm;</li><li>• Set teflon tubes;</li><li>• Power cord;</li><li>• Quick-start manual;</li><li>• Pressure plug 2x</li><li>• Feeler gauge</li></ul>	<ul style="list-style-type: none"><li>• Paint roller set;</li><li>• Level 60cm;</li><li>• Level 40cm;</li><li>• Wood glue;</li><li>• Heater block tool;</li><li>• Nozzle tool;</li><li>• Allen key 2.5mm;</li><li>• Nozzle 0.8mm;</li><li>• Nozzle 1.2mm;</li><li>• Set teflon tubes;</li><li>• Power cord;</li><li>• Quick-start manual;</li><li>• Pressure plug 2x</li><li>• Feeler gauge;</li><li>• Nylon wheels 4x</li></ul>	<ul style="list-style-type: none"><li>• Paint roller set;</li><li>• Level 60cm 2x;</li><li>• Wood glue;</li><li>• Heater block tool;</li><li>• Nozzle tool;</li><li>• Allen key 2.5mm;</li><li>• Nozzle 0.8mm;</li><li>• Nozzle 1.2mm;</li><li>• Set teflon tubes;</li><li>• Power cord;</li><li>• Quick-start manual;</li><li>• Pressure plug 2x</li><li>• Feeler gauge;</li><li>• Cabinet key;</li><li>• Machine feet 4x;</li></ul>

### Optional parts

- Spare print head;
- Level gauge, for easy surface levelling the print bed;
- Grease gun for maintaining your Builder Extreme;
- Grease.

Please contact your local reseller or [helpdesk@builder3dprinters.com](mailto:helpdesk@builder3dprinters.com) for more information.

# Manual Builder Extreme 1000/1500/2000 PRO

## Installing the machine

### Correct Surface

Be sure to place the Builder Extreme on a firm surface and be sure that there is more than 1 meter of space around the machine to perform maintenance.

### Installation

Levelling the printer is important for making good quality prints.

**Make sure that the Builder Extreme is used in a surrounding temperature between 15-32°C.**

### Level the printer

1. Place the printer on a stable floor and check if the printer is levelled

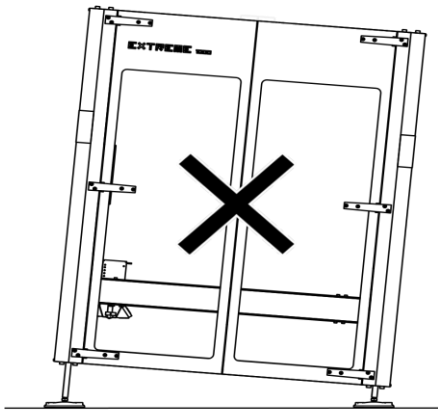

2. Spirit level

Level the printer with the included spirit levels. Check, and correct if necessary, all the three directions with the spirit level as shown. Correct the levelling of the machine using a wrench to move up or down the machine feet.

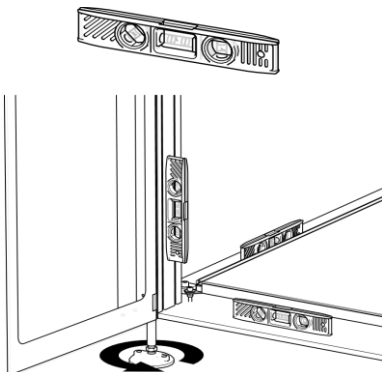

## Manual Builder Extreme 1000/1500/2000 PRO

### Extreme 1500 PRO wheels

Only the Extreme 1500 PRO is supplied with a set of wheels for easy transport through doors and in elevators. Move up the machine feet so the wheels can be mounted under the machine. Lower the machine feet so the wheels are on the ground and the machine can easily be transported to the final location. There the machine can be levelled, so as the wheels do not touch the ground.

### Switching on the battery pack

When the machine is levelled, the battery pack has to be switched on (when the battery box is on, light in the box switches on). In Extreme 1000 PRO/1500 PRO the battery pack is connected to the back of the control box, Extreme 2000 PRO has a switch in the top drawer.

### Bed levelling

During the assembly process, the build plate of the machine and the bed levelling were adjusted, so the space between the build plate and nozzle is 0.25 mm when Z axis of the machine is in the “Auto home” position. This 0.25 mm is called bed level position.

After transport and installing the machine, it is important to check this gap of 0.25 mm.

Perform a surface test. The standard G-code is uploaded into the internal memory of your machine. If the surface test is fine, the machine is ready to use.

The surface test is okay, when the test print looks like the pictures below and it sticks firmly to the build plate.

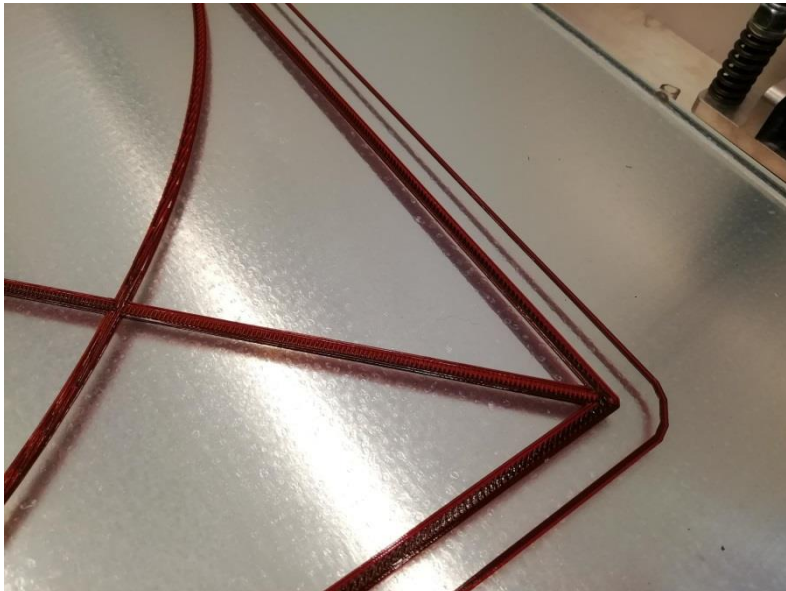

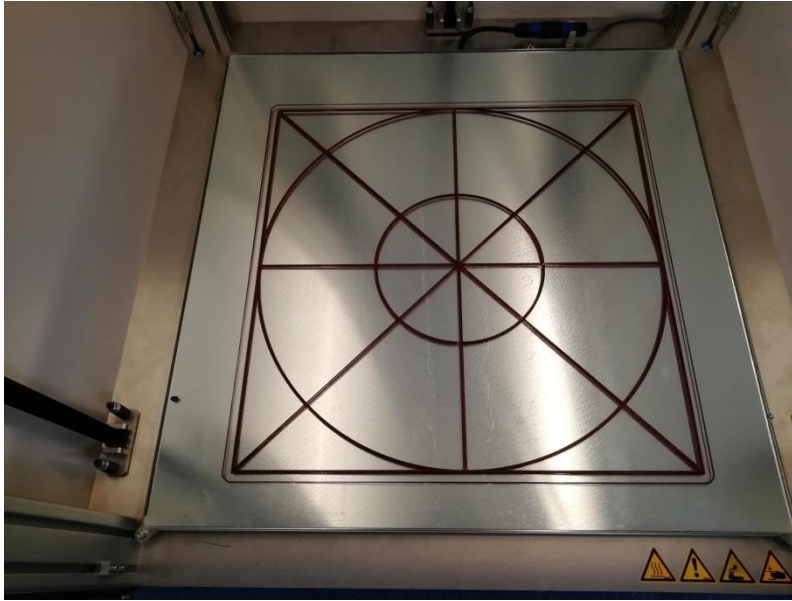

**Manual Builder Extreme 1000/1500/2000 PRO**

Missing lines in the surface test indicate that the nozzle is too close to the build plate at that certain point. The bed level needs adjustment. The nozzle needs to be moved farther from the build plate.

When the surface test does not stick to the build plate or becomes loose during printing, the nozzle is too far from the build plate. The bed level needs adjustment. The nozzle needs to be moved closer to the build plate.

## Manual Builder Extreme 1000/1500/2000 PRO

### How to adjust the bed level position

The machine uses 3 pcs. Z-sensors mounted in the print head frame, to determine the Z axis home position. These sensors are triggered by adjustable flags in the poles of the machine. Two flags are located in the left- and right front poles, one flag in the left rear pole.

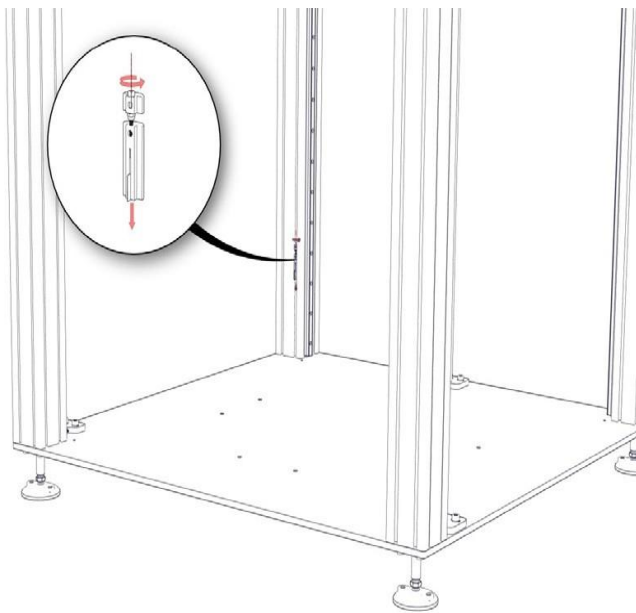

## Manual Builder Extreme 1000/1500/2000 PRO

These flags can be adjusted in height so the bed level position can be corrected if necessary.

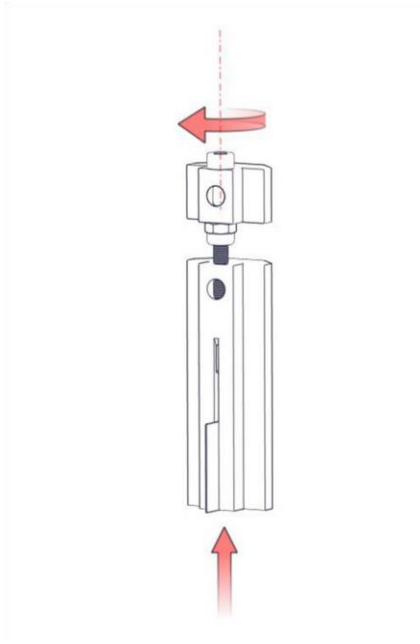

Looking from the top position:

- Turn clockwise and the nozzle moves away from the build plate
- Turn counter-clockwise and the nozzle moves closer to the build plate;

For every complete turn that is done there is a 0.5 mm displacement of the nozzle according to the build plate.

**If there is an adjustment needed, do not adjust more than 1/2 of a turn at a time.**

**Adjust the flags on the side of the build plate where the bed level adjustment is needed.**

**After adjusting the flags, always perform “Auto home”. Then the machine is in its new adjusted position!**



## Manual Builder Extreme 1000/1500/2000 PRO

### Dual print head

**Warning! Make sure that the head is cooled down before maintenance is performed on the head!**

For easy maintenance, it is possible to remove the print head from the print head frame.

**Use the “replace head” option in the “Customer” → “Service” menu before changing the print head.**

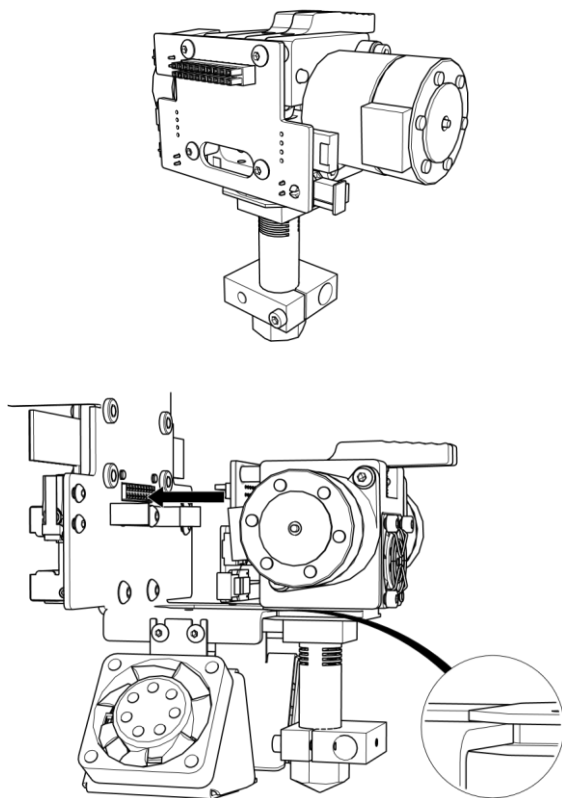

Be sure the connectors are aligned in front of each other. Push the print head until the connectors merge into each other.

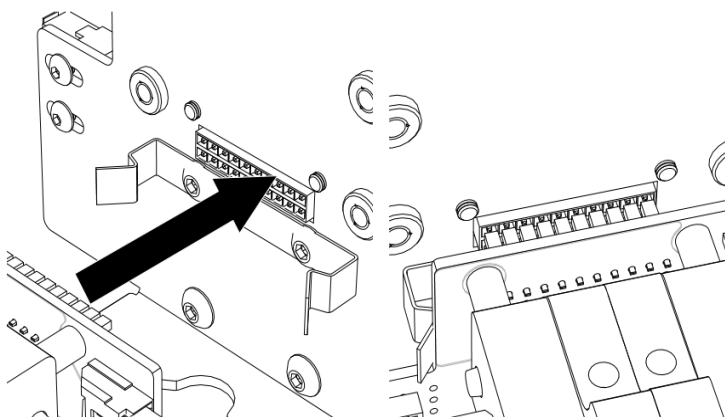

## Manual Builder Extreme 1000/1500/2000 PRO

Check if the clips are snapped into place

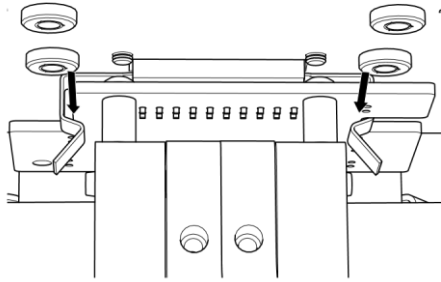

**Make sure when printing with the Dual-Feed both extruder holes are filled with a filament.**

### Inserting filament

Be sure the print head is pre-heated. Push down the button and insert the filament until you feel some resistance. Now insert the second filament by doing the same. Keep pushing the buttons, and then push down the filament until it comes out of the nozzle. Do this with both filaments.

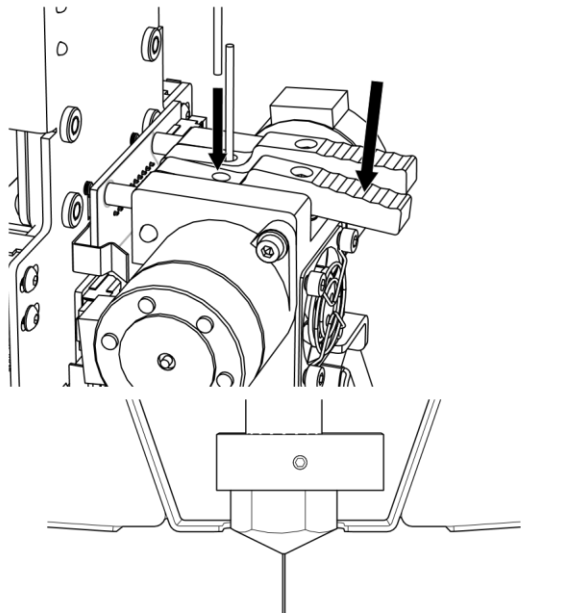

Adjusting the screws in the buttons, using a 2.5 mm Allen key, the pressure on the filament by which it is pressed against the extruder wheels can be adapted. These are adjusted during the fabrication process, so normally they do not need adjustment. Turning clockwise increases the pressure, turning anticlockwise will decrease the pressure on the filament.

## Manual Builder Extreme 1000/1500/2000 PRO

### Changing nozzle

**Be careful when performing any work on a heated print head!**

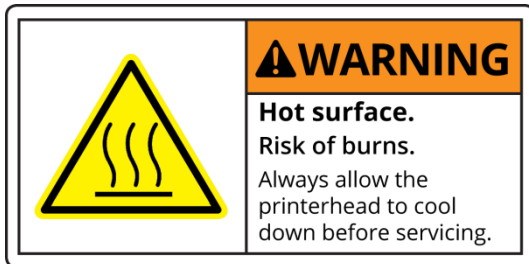

Preheat the nozzle.

Remove the nozzle using a 17 mm wrench or the included tool.

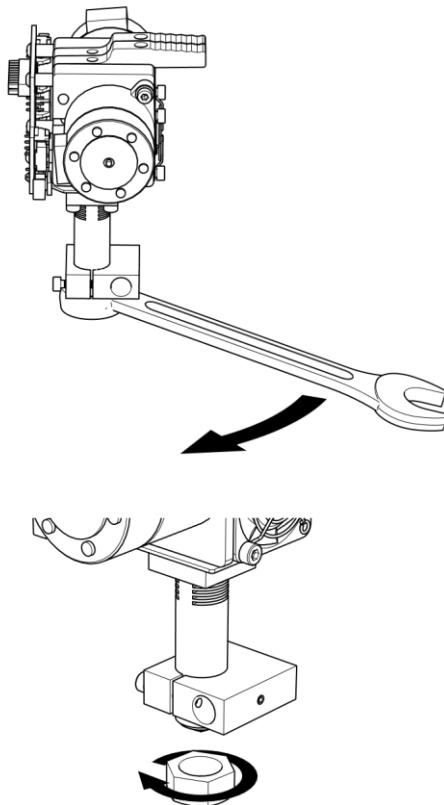

Mount the new nozzle the reverse way of taking it off. Be sure the connected surfaces are clean. Tighten the new nozzle, do not do it too strong (no more than 7Nm). Check the nozzle for the right torque when it is pre-heated.

## Manual Builder Extreme 1000/1500/2000 PRO

### Nozzle diameters

The nozzles are marked on the top of the nozzle.



0.4 mm

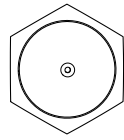

0.8 mm

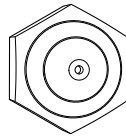

1.2 mm

When using nozzles 0.8 and 1.2 mm be aware the extrusion speed needs to be very high. To avoid under extrusion tighten the pressure screws in the levers.

### First layer height

The first layer height depends on the size of the nozzle. Here are a few examples for the different nozzle sizes:

Nozzle 0.4 mm                      First layer 0.3 mm

Nozzle 0.8 mm                      First layer 0.6 mm

Nozzle 1.2 mm                      First layer 0.8 mm

## Manual Builder Extreme 1000/1500/2000 PRO

### Filament detection

The machine is equipped with filament detection. It detects the moment when there is no filament in one of the detection units and activates the sounds signal. The Extreme 1000 PRO and 1500 PRO have the detection on top of the machine. The Extreme 2000 PRO has the detection in the filament draw.

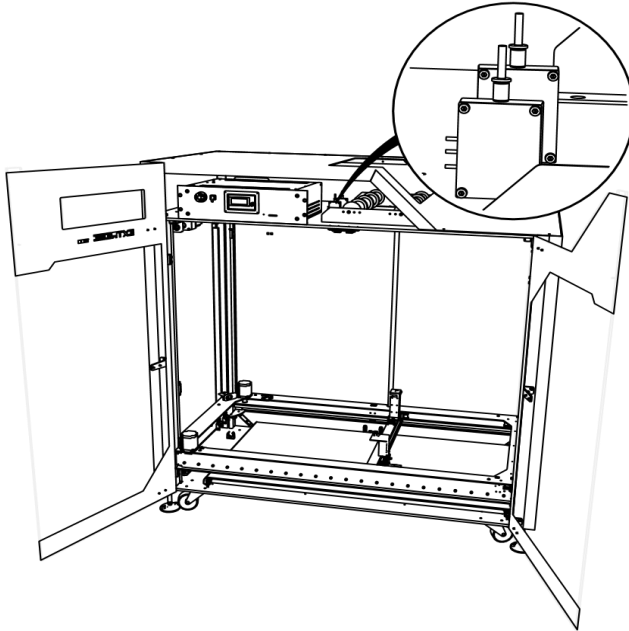

When inserting filament in the machine, push the filament through the filament detection unit and insert the filament in the print head. The printer will now detect the filament. If one of the extruders runs out of filament the printer will automatically pause and move to a pause position where it will wait for the user to enter new filament. Press the button to preheat and change filament. Then push the button to restart the machine.

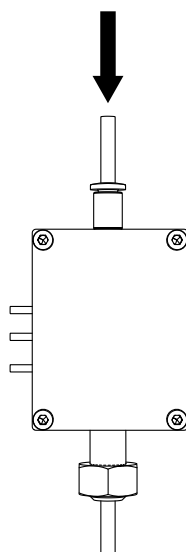

## Manual Builder Extreme 1000/1500/2000 PRO

### Start Printing

#### Auto home

When you power up your Extreme, the machine has to be auto-homed. You can only move the machine when this action is done.

#### Adhesive layer

For perfect adhesion between your print and the aluminium build surface be sure that the layer of glue is in perfect state. Check this before the start of every print. The layer of glue has to cover the complete surface of the build plate. If the layer is not covering the complete build surface, apply a new layer using the supplied paint roller set and the wood glue. Put 1/3 glue and 2/3 water into the paint roller set and give it a good mix. Before applying the glue to the build plate, pre-heat it to 50°C, then apply the glue to the build surface using the paint roller. **Apply an even coat and be sure that no glue is coming under the aluminium build plate!**

#### Preheat

It can be convenient to pre-heat the Extreme Builder when in the mean time doing some preparations before starting the actual printing process. Pre-heating can be done using the user interface.

#### Timeout heater

When the machine is not used for 30 minutes, the machine stops heating. The print head stops heating after 30 minutes, the heated bed after 3 hours. After your print is finished, all heaters will stop heating automatically.

## Manual Builder Extreme 1000/1500/2000 PRO

### G-code/Slicing

To start printing, the printer needs a G-code file. The G-code can be generated by a so called slicer. We advise to use Simplify3D. The possible input file types for slicing software are: STL/OBJ/AMF/DAE files. To generate the correct G-codes for the Builder Extreme printers there are printer-profiles that can be downloaded from the Builder3dprinters.com website. Be sure to use the profile that fits your type of machine, nozzle diameter, materials, etc. When a G-code file has been generated it can be put on an USB-stick or send to the machine via Wi-Fi using the Builder web portal.

**Exclusive G-code command for the Builder dual extruder:**

- **G93 Rxx: You can adjust the ratio of the 2 extruders in the G-code. Put this code in after the last tool change, before the printing starts, see example below.**

```
G28 ; home all axes
M204 S1500 ; default acceleration
M205 X15.00 ; maximum X Y jerk
G92 E0
G1 E-3.0000 F900
G1 Z0.420 F1998
; process Materiaal collorfab
; layer 1, z = 0.420
T0
; tool H0.420 W0.576
; skirt
G93 R50
G1 X72.545 Y76.018 F9000
G1 E0.0000 F270
G92 E0
G1 X72.555 Y76.008 E0.0015 F3360
G1 X74.748 Y73.914 E0.3217
G1 X74.758 Y73.804 E0.2222
```

**When using 1 color/material, always use both extruders 50/50% to prevent clogging the nozzle!**

**Be sure the build plate is cooled to room temperature before removing a finished object!**

**We do not recommend to print multiple objects in one print. If failure occurs, all the object will fail and the time that is won by printing multiple object is minimal.**

## Manual Builder Extreme 1000/1500/2000 PRO

### UPS function, power fail

The UPS function activates when the main power supply fails.

Detection takes place on/after: Power failure and resumption.

Battery pack needs to be charged. The battery will be charged when the main power switch is on, this is indicated by the led in the front panel.

#### **When the main power is off the battery will not be charged!**

**Be aware that it takes a few ours to recharge the batteries when the machine is not used for a couple of days.**

1. Time interval detection "POWERFAIL\_DELAY" is set to 10sec.
2. After about 10 seconds, a "POWERFAIL" popup appears on the screen
3. The internal buffer is completed.
4. The print is paused.
5. The printer goes to  $Z = Z + 10\text{mm}$
6. The position is saved
7. A power fail restore file is created.
8. The Home screen status changes to "Powerfail!"
9. Once the power is restored, the print head a bed will start heating. Once the current temperature > target temperature-3 the print will continue. The print will automatically continue without any user interaction needed.
10. After the power returns, the printer deletes the powerfail restore file.
11. If the battery is empty and power has not yet been restored the printer will shut down. Once you reboot and press the print button in the home screen, you get a message: "powerfail has been detected". You have the option to continue the print in this menu. If you click "cancel", the restore file is deleted and continuing the failed print is no longer possible.

#### **If the bed is cooled down to <40°C please check if the object is still stuck to the bed!**

**\*Note : When printing from USB the print progress will be saved and after a power shutdown. The print can be resumed from the user interface. Resuming the print is not possible from the Builder web portal however!**



## Manual Builder Extreme 1000/1500/2000 PRO

**File data:**

The power restore file contains following:

- The name of the file which was being printed.
- The restore file also contains the line (position) of where the print should continue.
- The current values of temperature, ratio, speed, federate, position, fan speed.

# Manual Builder Extreme 1000/1500/2000 PRO

## Maintenance

### Maintenance schedule

	Every print	daily	weekly	monthly	Quarter	Annually	2 years	Hours
State of the adhesive layer of the build plate	<b>X</b>							
Bed levelling (surface test)				<b>X</b>				
Checking the function of the work piece cooling fans				<b>X</b>				
Check the filament detection function				<b>X</b>				
Cleaning the doors					<b>X</b>			
Greasing guides x/y axes								<b>1000</b>
Greasing the z axes								<b>2000</b>
Check the UPS function*					<b>X</b>			
Replace battery pack							<b>X</b>	
Cleaning filter electronic box					<b>X</b>			
Replacing filter of electronic box						<b>X</b>		
Check if the emergency stops functions					<b>X</b>			

\* If the machine does not have a power supply for more than one week, switch off the battery pack behind the filament spool holder.

## Manual Builder Extreme 1000/1500/2000 PRO

### Trouble shooting

<b>Problem</b>	<b>Solution</b>
No power	Is the power cable connected
Blocked nozzle/channel	Nozzle too close to the build plate (0.25mm), check bed levelling
	Always use 2 channels, 50/50
Bad print quality	Using the wrong nozzle diameter
	Using wrong print settings, temperature, speed, etc.
	Using wrong material
Blown fuse	Contact Builder 3D Printers (or the local reseller)
Object does not stick to the build plate	Nozzle is too far from the build plate (0.25 mm) check bed levelling
Machine cools down	If the machine is heating too long without being used, the heaters will stop heating.
Machine does not start printing	Surrounding temperature is too low, <5 °C

# Manual Builder Extreme 1000/1500/2000 PRO

## Dual print head maintenance

Between 1000/2000 hours the dual print head needs to be maintained. Depending on what materials are being printed.

If there are no obvious problems we advise to change the following parts, namely:

- Nr 7, tubes;
- Nr 4, thermal barrier.

If the print head is blocked we advise to also change the following parts, namely:

- Nr 1, nozzle;
- Nr 2, coupler.

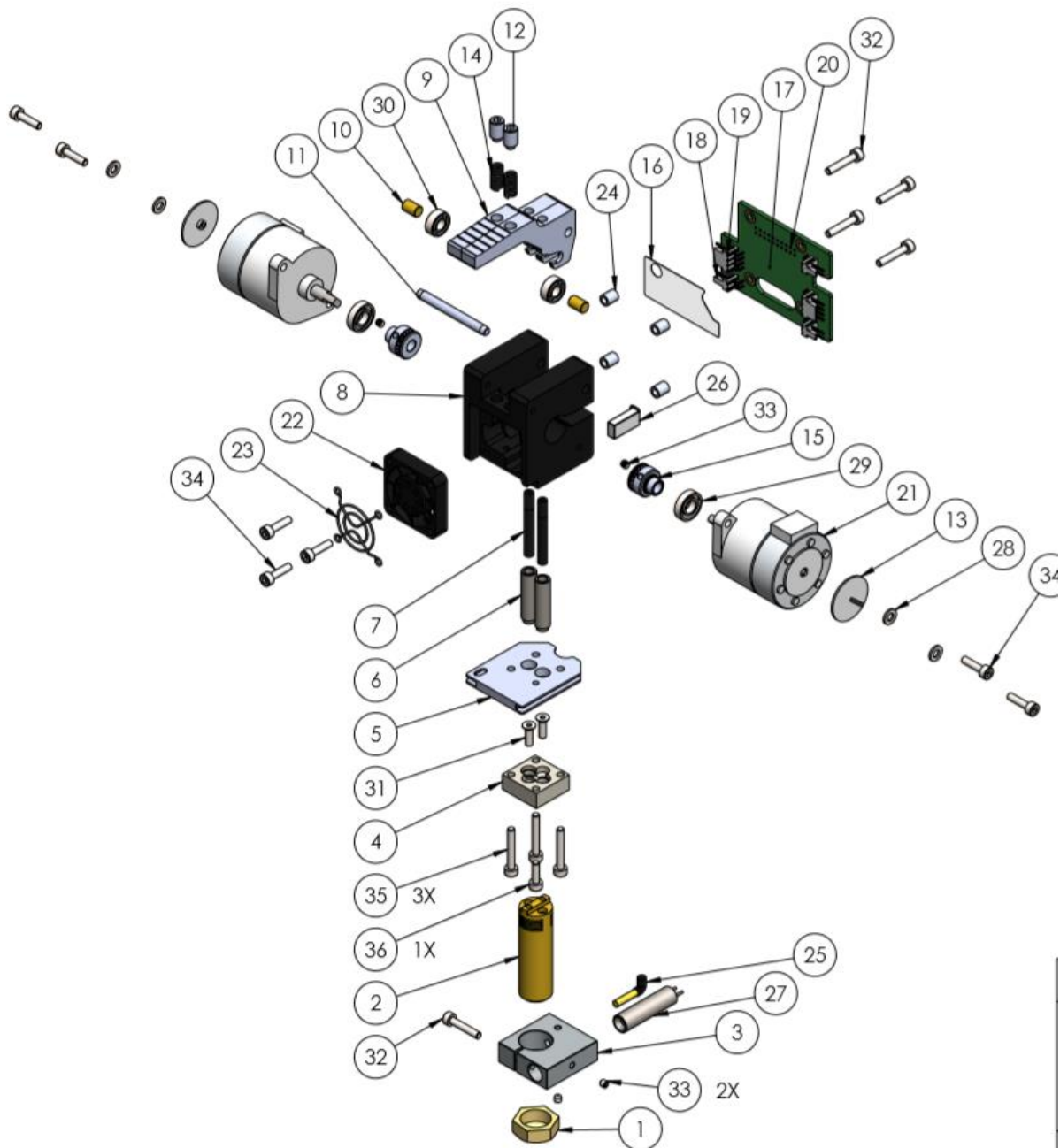

# Manual Builder Extreme 1000/1500/2000 PRO

## Attachment

### Technical specifications

Specifications	Extreme 1000 PRO	Extreme 1500 PRO	Extreme 2000 PRO
Technique	FDM/FFF		
Resolution	Low quality : 0.9 mm Normal quality: 0.4 mm High quality: 0.2 mm		
Position accuracy stepper	X: 10 micron Y: 12.5 micron Z: 2.5 micron		
Build Volume LxWxH	700x700x820	1100x500x820	700x700x1700
Printer external dimensions LxWxH	1006x1016x1500	1501x800x1500	1343x1072x2190
Weight	225 kg	225 kg	262 kg
Frame material	Aluminium		
Print bed (platform)	(Heated) Aluminium		
Certification	CE		
Surrounding operating temperature in °C	15-32°C		
Storage temperature in °C	0-35°C		
Operating nozzle temperature in °C	180-260°C		
Heated bed temperature in °C	Max 60°C		
Filament diameter	1.75mm		
Maximum print speed	300 mm/s		
Maximum travel speed	500 mm/s		
Nozzle diameter	0.4/0.8/1.2*		
Removable print head	Yes		
Power supply	AC 100-240V 50/60Hz		
Power consumption	800-1800W		
Connection	WIFI		
Data reader	USB stick		
CNC programming Language	G-code		

\*for the nozzle 1.2 mm, maximum print speed depends on the shape of the product.

## Manual Builder Extreme 1000/1500/2000 PRO

### User Interface

Via the user interface the machine can be controlled. Attached to this document is the menu structure and the description of this menu.

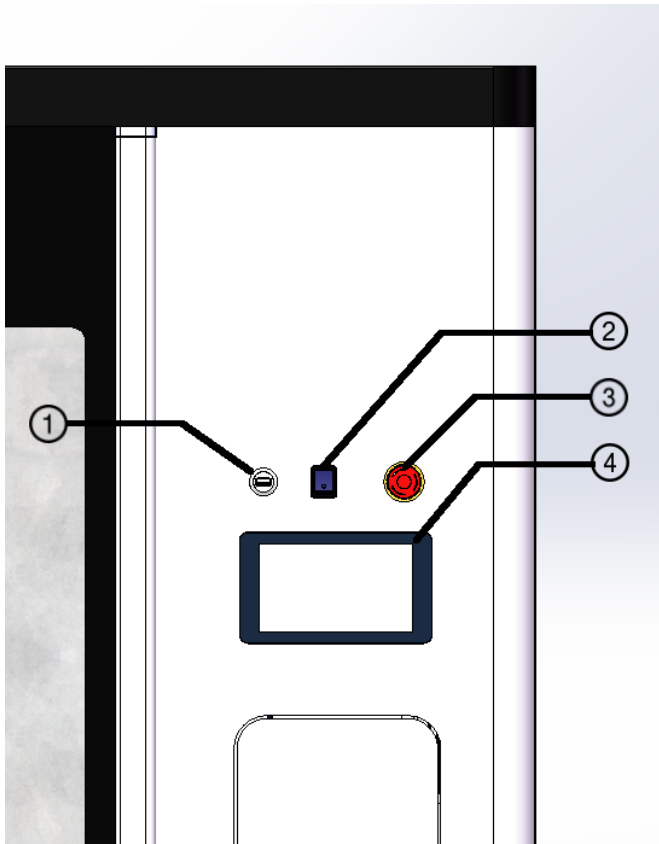

**1. USB**

Insert a USB card with the G-code.

**2. On/off switch**

The on/off switch turns the machine on/off. The machine can only be switched on when the main power is on indicated by the LED light.

**3. Emergency button**

Pushing the emergency button in case of an emergency situation will shut off the power of the printer. Rotate the emergency stop to deactivate.

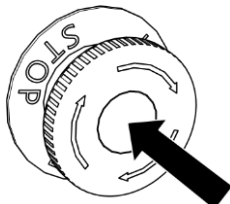

**4. User interface**

Used to control the printer with a touch screen.

# Manual Builder Extreme 1000/1500/2000 PRO

## Homescreen

Printer idle:

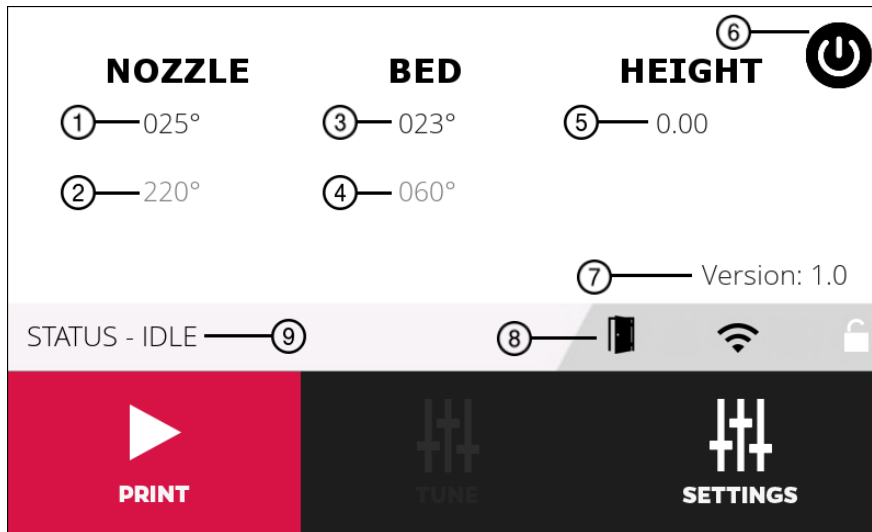
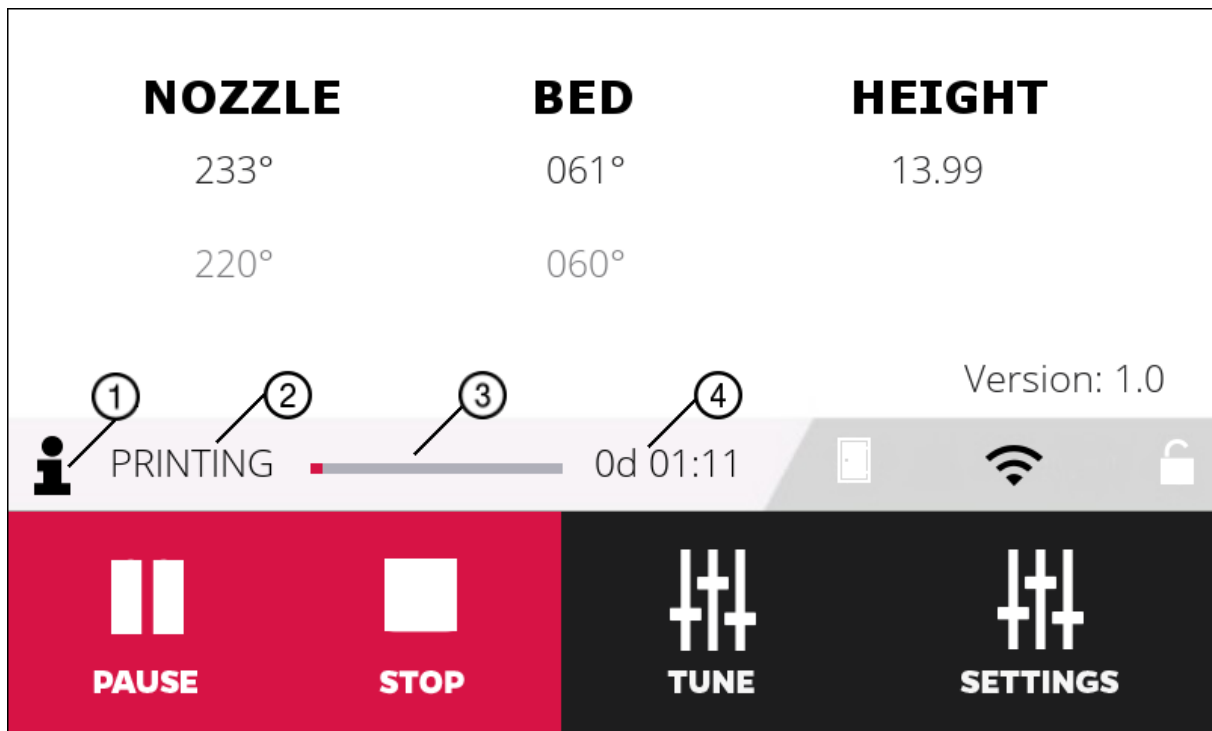

Figure 1: Home screen when idle

1. Nozzle current temperature
2. Nozzle target temperature
3. Bed current temperature
4. Bed target temperature
5. Current height of the printer head
6. Shutdown-button
7. Current software version
8. Icon bar, from left to right:
  - a. Door icon, use it to open the door. The icon will turn grey when the printer is printing.
  - b. Network icon, active if the printer has a network connection, either WIFI or Ethernet. If you press the icon you will get a qr\_code to scan with your phone. This will load the browser application to control the printer.
  - c. Lock icon, active when printer is locked. If you press the icon you will move into the lock screen.
9. Current printer status. This status message will show what the printer is doing. It will also show error messages when something is wrong.

**Manual Builder Extreme 1000/1500/2000 PRO**

Printer printing:



1. Info button, press it to see current print file
2. Printer status
3. Progress bar. Fills up when printing, print done when full.
4. Time since print started



## Manual Builder Extreme 1000/1500/2000 PRO

### Select file:

If you click the print button in the home screen you go to a file selection screen. You can select which print file you want to use in this screen.

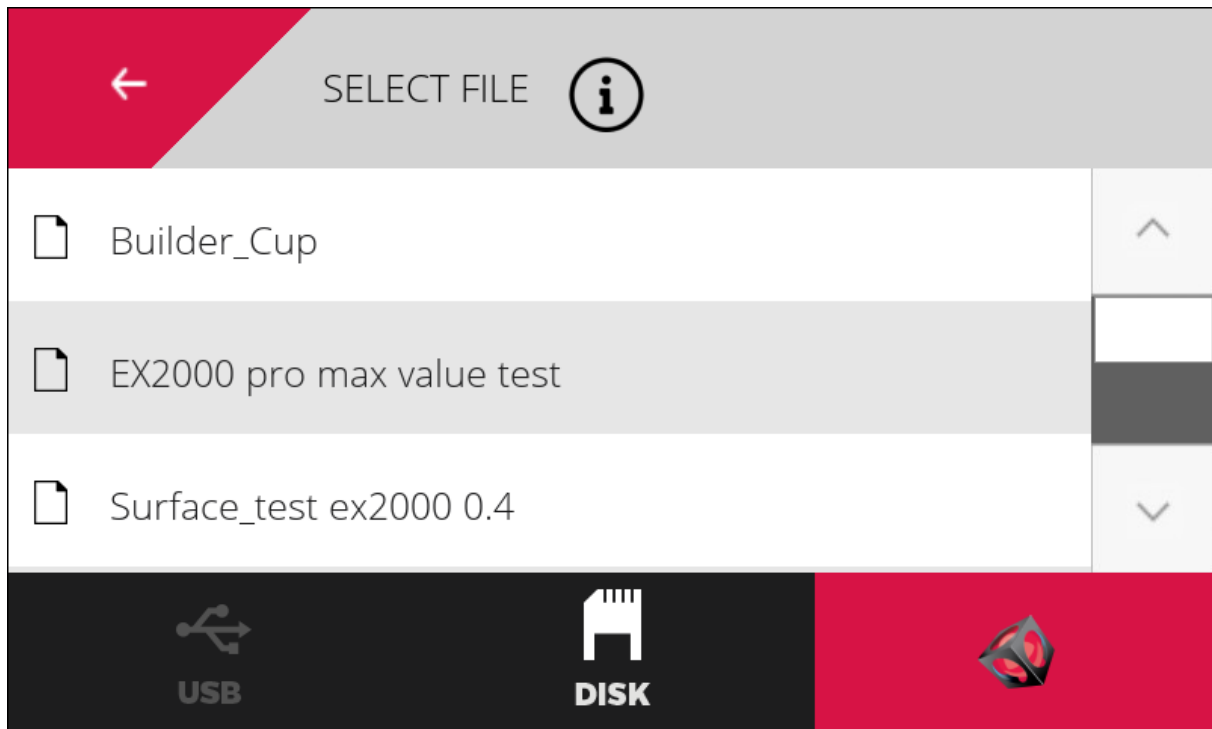

On the bottom there are 3 icons:

- USB
- DISK
- Builder Logo

#### **USB:**

These are the different file locations. If you wish to print a file from USB you click the USB icon. You can now select a file from the USB drive. Once you selected a file, this file will now copy to the SD-card of the printer. The print will start when the copy is done.

As soon as the printer starts printing, you can remove the USB-drive.

#### **DISK:**

This is the local storage of the printer. There is about 25GB of free space for the user's gcode-files.

#### **Builder Logo:**

These are the Builder default print-files. These are often used to test the printer, and if the user ever needs support, we might use one of these default print files to test whether the problem is located in a gcode file or the printer. These files cannot be deleted.

## Manual Builder Extreme 1000/1500/2000 PRO

### Settings:

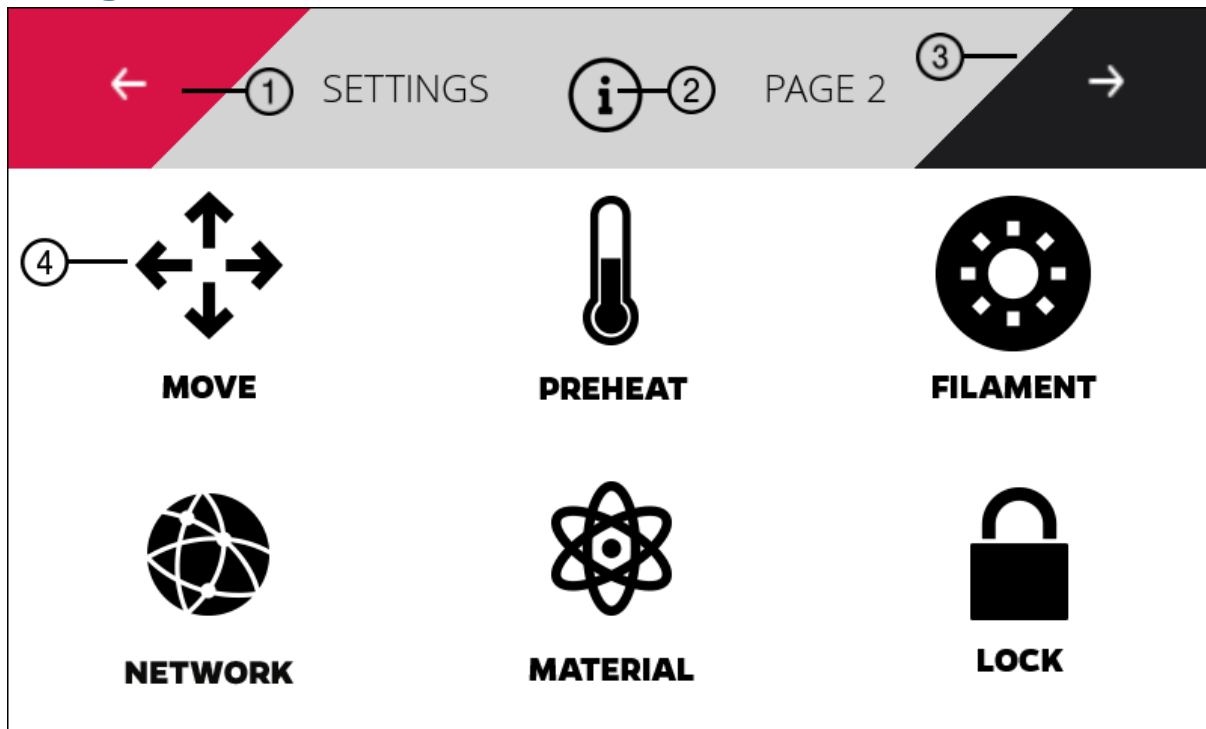

1. Back button, return to previous screen
2. Information button, gives you useful information about the current screen. Can be removed in configure menu (screen settings page 2).
3. Next button, go to page indicated to the left of the button (page 2 in this case).
4. Click the different icons to move to the menu mentioned (move menu in this case).

The different setting menus:

- **Move** – move the nozzle.
- **Preheat** –set the desired temperature for the bed and nozzle here
- **Filament** –extrude and change filament
- **Network** – select a WIFI connection. You can also see your Wifi and Ethernet IP-address here.
- **Material** – select the material you wish to use here.
- **Lock** – locks the printer to make sure it can't be touched while printing.
- **Tutorial** – help videos
- **Camera** – shows you a view of the webcam image
- **Light** – set brightness and turn lights on/off
- **Configure** – various configurations for your printer
- **Info** – general information about your printer

*Note: While printing several menu options are disabled.*

## Manual Builder Extreme 1000/1500/2000 PRO

### Settings windows:

#### Lock

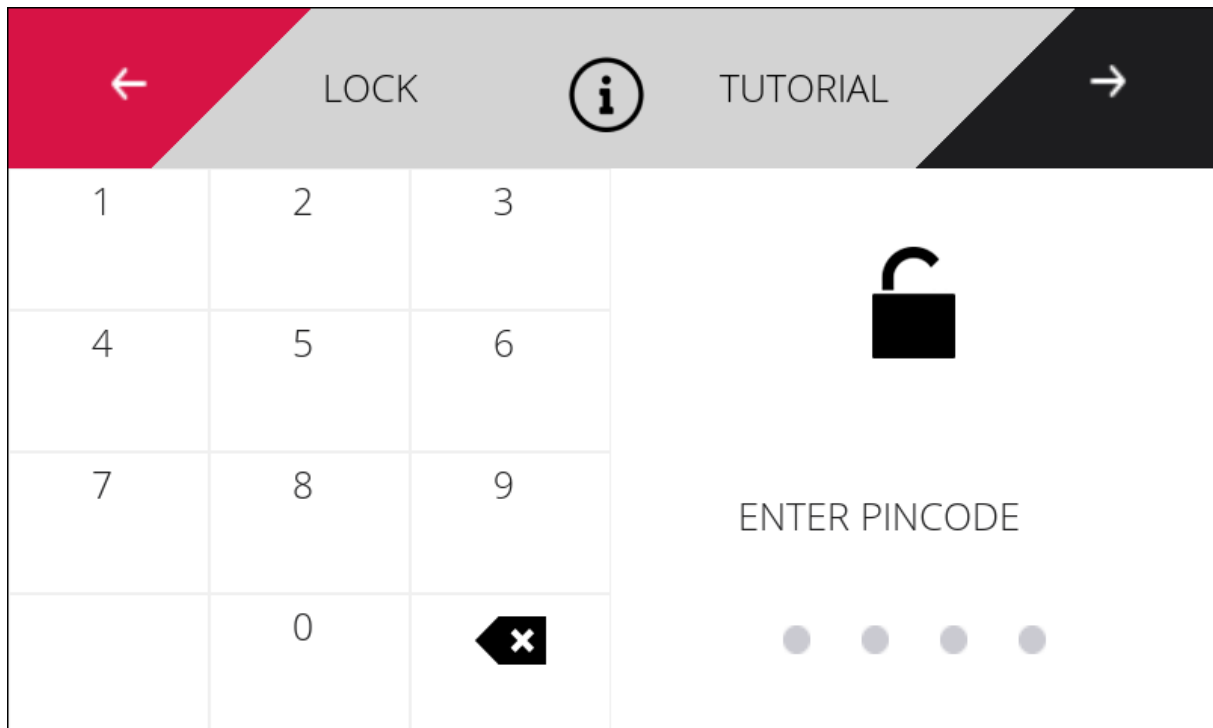

Enter a code twice to lock the printer. You can unlock the printer in this menu afterwards by entering the same code again. If the printer is locked, the browser is also locked.

When the printer is locked you are not able to perform any action until the printer is unlocked again.

## Manual Builder Extreme 1000/1500/2000 PRO

### Material:

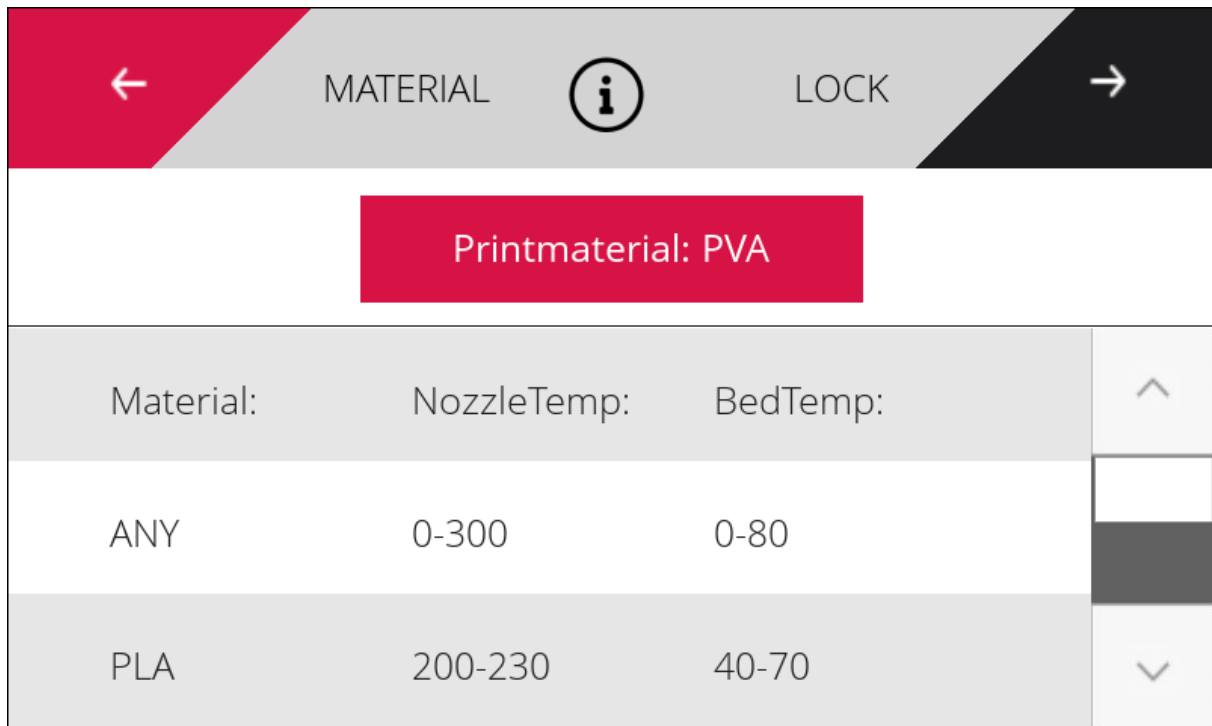

The material window is used to protect users from mistakes in their gcode-files.

If a gcode file is used with a nozzle temperature setting of 100°C and PLA is used as material, the print would normally fail. If you have **print assistance** enabled in the configure menu and selected PLA as the material to use, the software will recognize that 100°C is too low to print PLA and correct the print temperature to the average of the boundaries (in this case 215°C).

To disable this function, either disable **print assistance** in the configure menu or select “ANY” as printed material.

## Manual Builder Extreme 1000/1500/2000 PRO

### Network:

To log into the printer remotely from a browser the printer needs to be logged into the same network as the device you wish to use.

To connect the printer to a network via Ethernet plug in the Ethernet cable.

To connect the printer to a network via WIFI go to the network screen in options and select WIFI. In this screen you can select the network you want to use and enter the password.

Once the printer is connected to a network the printer has an IP-address. The printer can have two IP addresses simultaneously if it is connected to both WIFI and Ethernet. You can view the IP address of your 3D printer in the main screen's status bar. If you click the WIFI icon in the main screen you see an image of a QR-code. On the bottom of this page you can also see the IP-address.

If an Ethernet cable is used, the ip shows will always be the Ethernet-IP address.

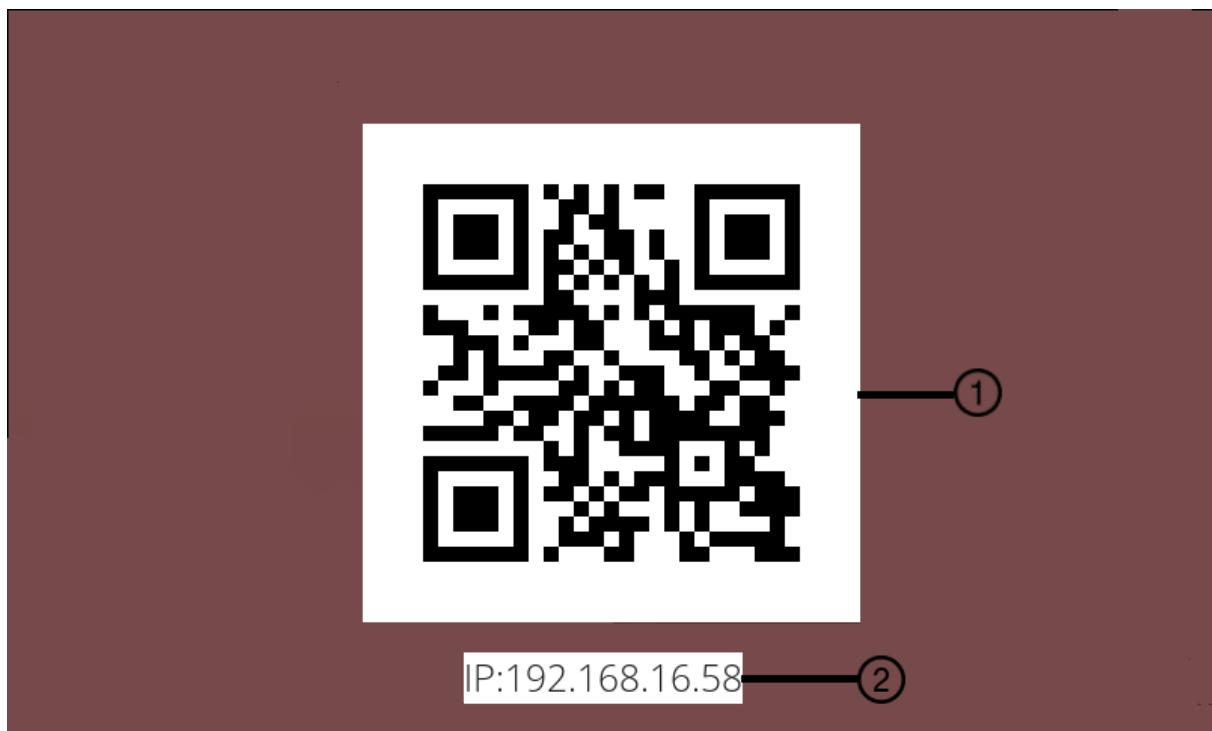

1. QR-code to scan with a phone.
2. IP address

Scan the QR-code on a phone and open the corresponding page in a browser to enter the printer's browser page. You can also enter the IP address manually into any internet browser.

*Note: make sure the device is connected to the same network as the 3D printer.*

## Manual Builder Extreme 1000/1500/2000 PRO

The browser should show the following site:

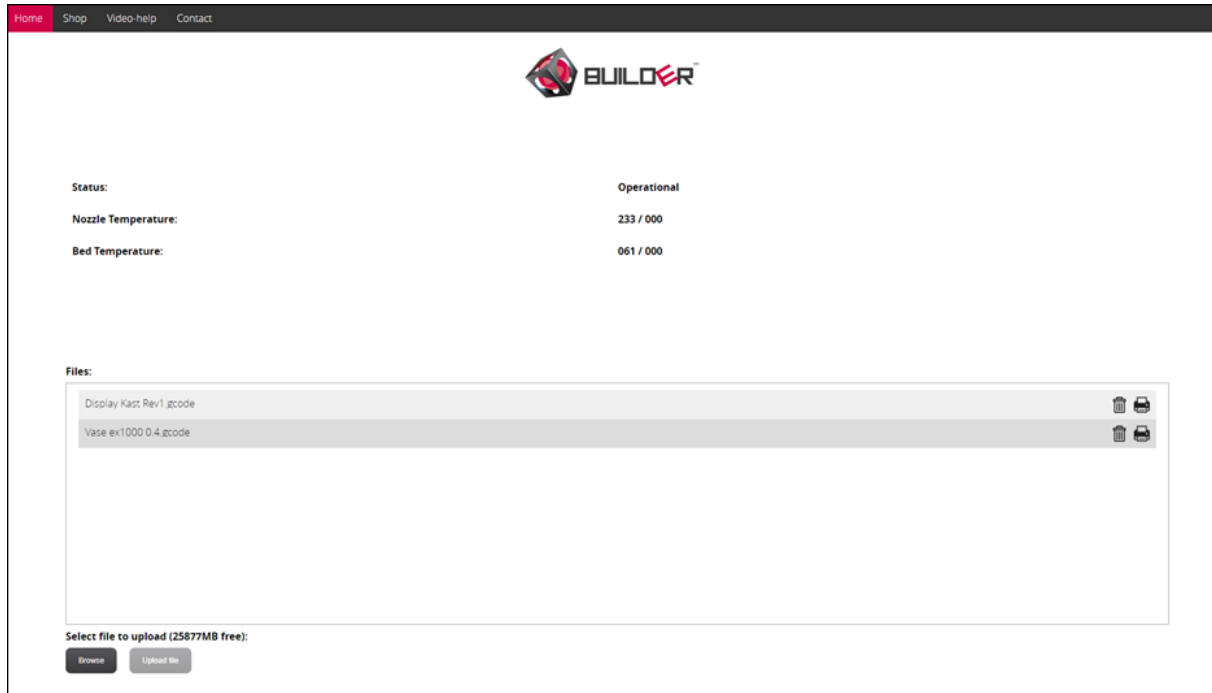

In this screen the user is able to start or stop a print. You can also add or delete files. At the bottom of the page there is a live webcam image of the print.

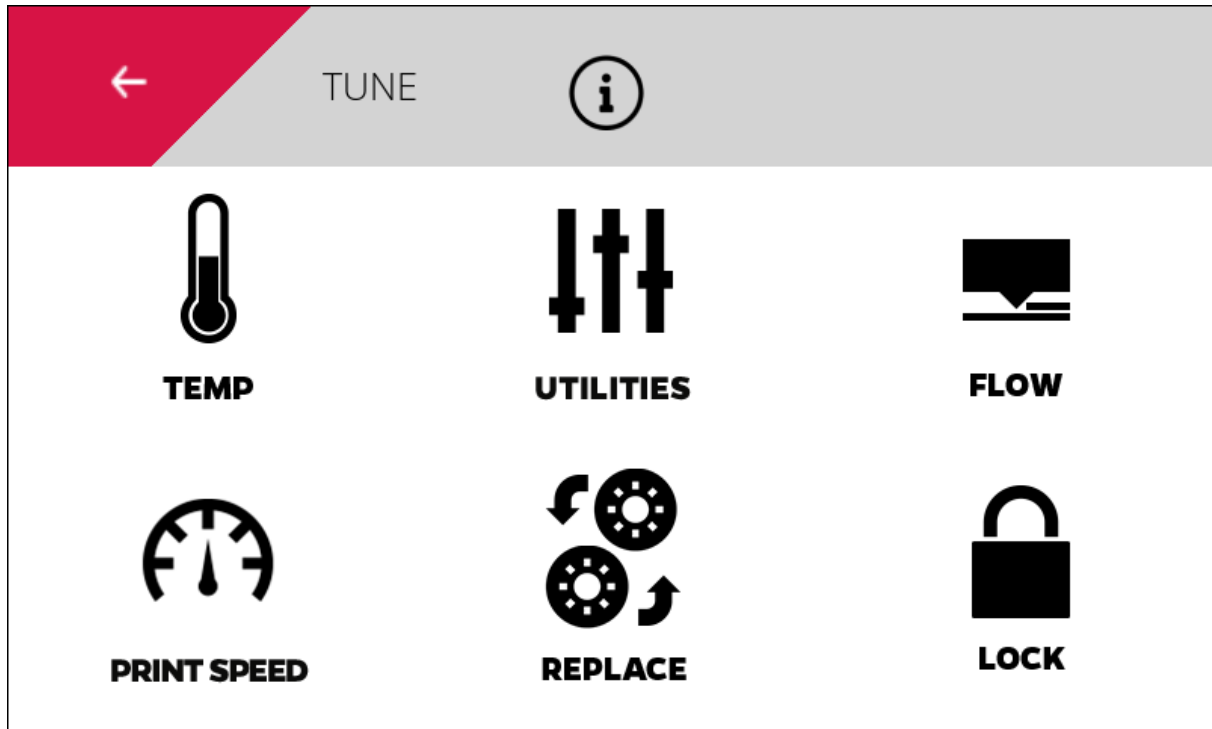
**Manual Builder Extreme 1000/1500/2000 PRO****Tune Menu:**

- **Temp** – set temperature for bed and nozzle
- **Utilities** – change fan speed, extraction or turn lights on/off
- **Flow** – change the amount of filament used and which nozzle is used
- **Print speed** – change print speed
- **Replace** – replace filament used
- **Lock** – lock the printer

## Manual Builder Extreme 1000/1500/2000 PRO

### License:

After you have paid for the Builder 3D printer you will get a license code. This code can be used to activate your printer. If you do not activate your printer it will stop working after printing seven days.

To check if your printer has been activated you can go to the info screen in the settings menu.

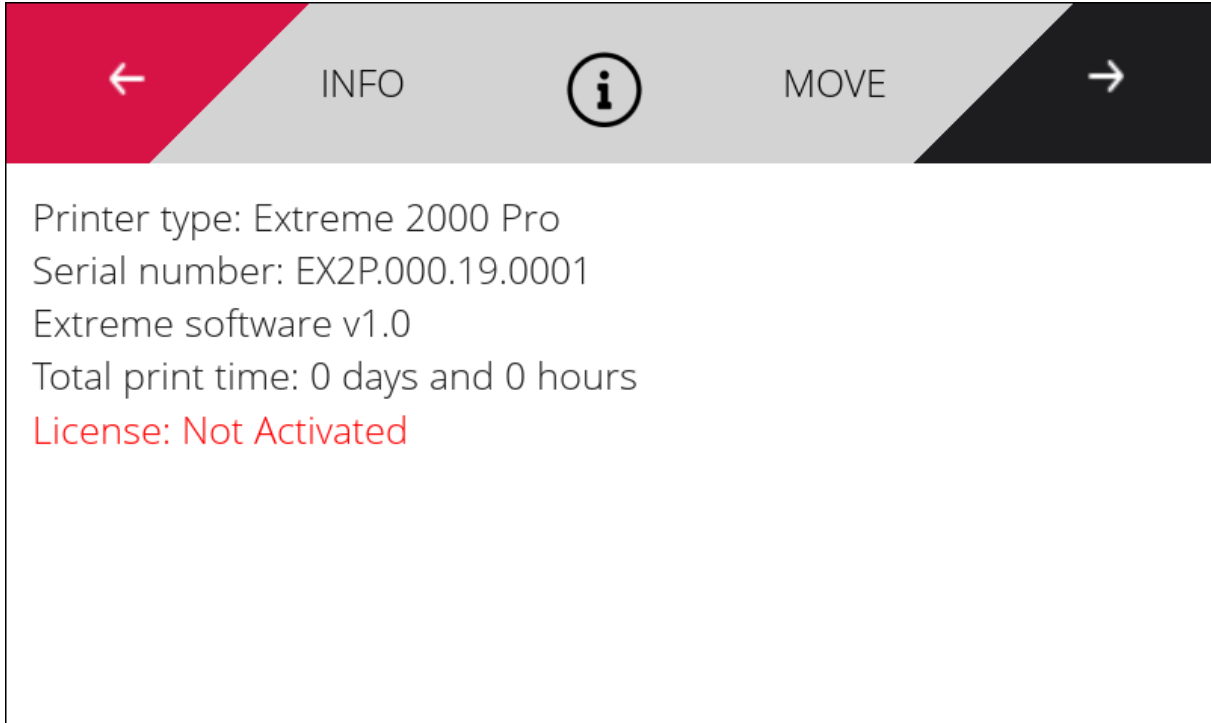

On the bottom of this window you see the red text: License: Not Activated.

To activate your printer go to the service menu. Click customer and 'Enter License'.

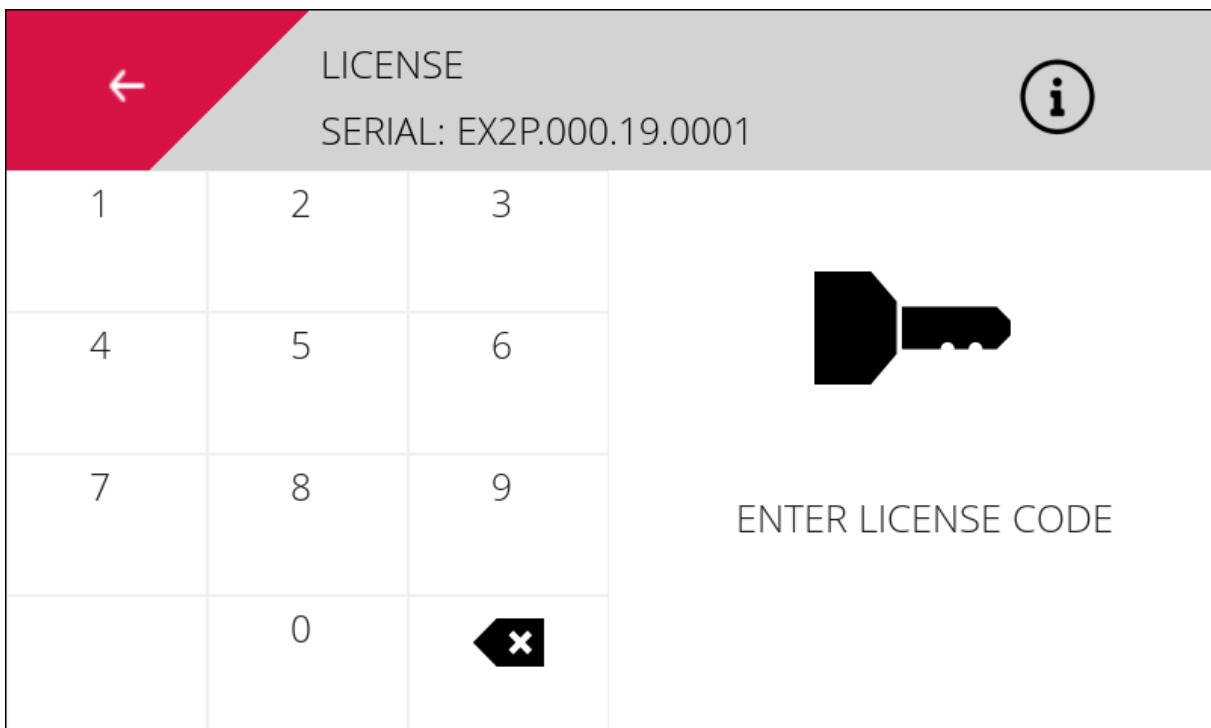



## Manual Builder Extreme 1000/1500/2000 PRO

You can enter your license code in this screen. If the code is valid, the printer is now activated! You can check this in the info menu. The red text will now be green and read: License activated!

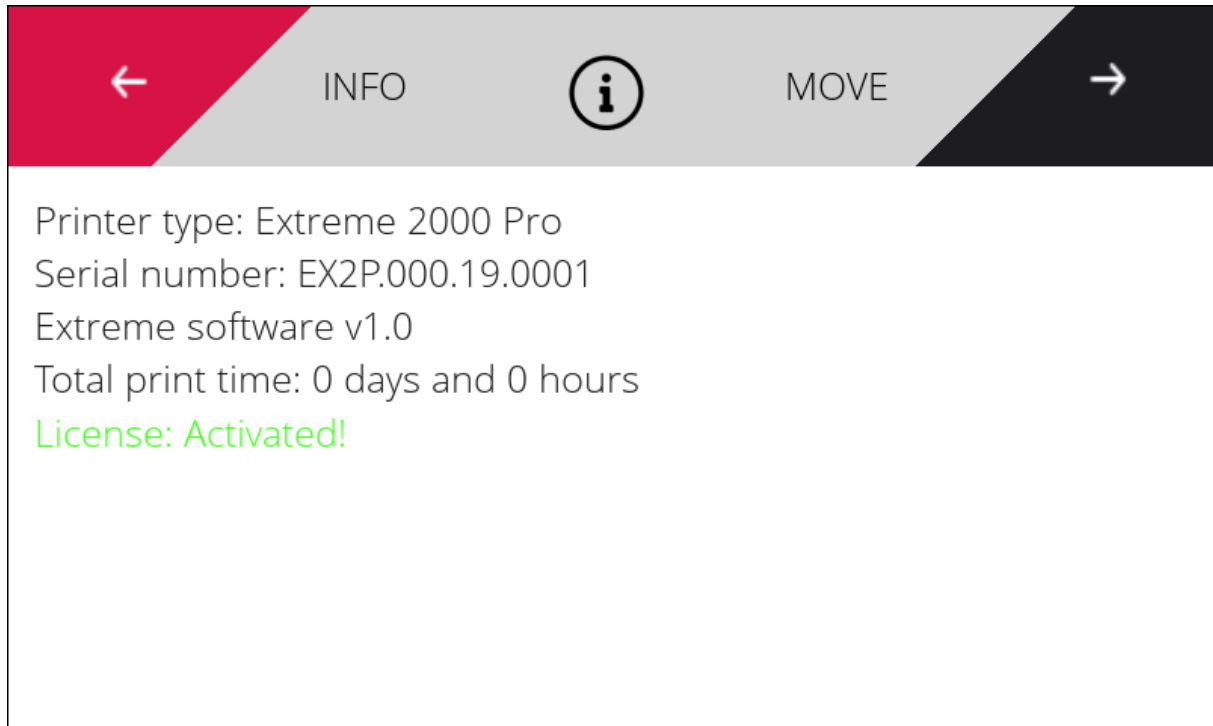

# Manual Builder Extreme 1000/1500/2000 PRO

## Machine notifications:

Notifications	Meaning
"STATUS - IDLE"	Machine is ready
"PAUSED"	Printer paused
"PRINTING"	Printer printing
"HEATING"	Printer is heating
"EMERGENCY"	Emergency button pressed
" FILAMENT"	No printer filament detected
"POWERFAIL"	No power supply

## Additional information

### G-code list

Gcode	Meaning
G0,G1	Coordinated Movement X Y Z E
G28	Home all Axis
G90	Use Absolute Coordinates
G91	Use Relative Coordinates
G92	Set current position to coordinates given
G93	Set color ratio Rxxx .x (percentage front/left extruder)

### M-code list

Mcode	Meaning
M17	Enable/Power all stepper motors
M18	Disable all stepper motors; same as M84
M35	Select Remote printing with AstroBox and block sd-card menu
M36	Deselect Remote Printing
M82	Set E codes absolute (default)
M83	Set E codes relative while in Absolute Coordinates (G90) mode
M84	Disable steppers until next move
M104	Set extruder target temp
M105	Read current temp
M106	Fan on
M107	Fan off
M109	Sxxx Wait for extruder current temp to reach target temp. Waits only when heating Rxxx Wait for extruder current temp to reach target temp. Waits when heating and cooling
M114	Output current position to serial port
M140	Set bed target temp

## Manual Builder Extreme 1000/1500/2000 PRO

M190	Sxxx Wait for bed current temp to reach target temp. Waits only when heating Rxxx Wait for bed current temp to reach target temp. Waits when heating and cooling
M201	Set max acceleration in units/s <sup>2</sup> for print moves (M201 X1000 Y1000)
M203	Set maximum feed rate that your machine can sustain (M203 X200 Y200 Z300 E10000) in mm/sec
M204	Set default acceleration: S normal moves T filament only moves (M204 S3000 T7000) in mm/sec <sup>2</sup> also sets minimum segment time in ms (B20000) to prevent buffer underruns and M20 minimum feed rate
M205	Advanced settings: minimum travel speed S=while printing T=travel only, B=minimum segment time X= maximum xy jerk, Z=maximum Z jerk, E=maximum E jerk
M207	Set retract length S[positive mm] F[feed rate mm/sec] Z[additional zlift/hop]
M220	S<factor in percent>- set speed factor override percentage
M221	S<factor in percent>- set extrude factor override percentage
M302	Allow cold extrudes, or set the minimum extrude S<temperature>.
M999	Restart after being stopped

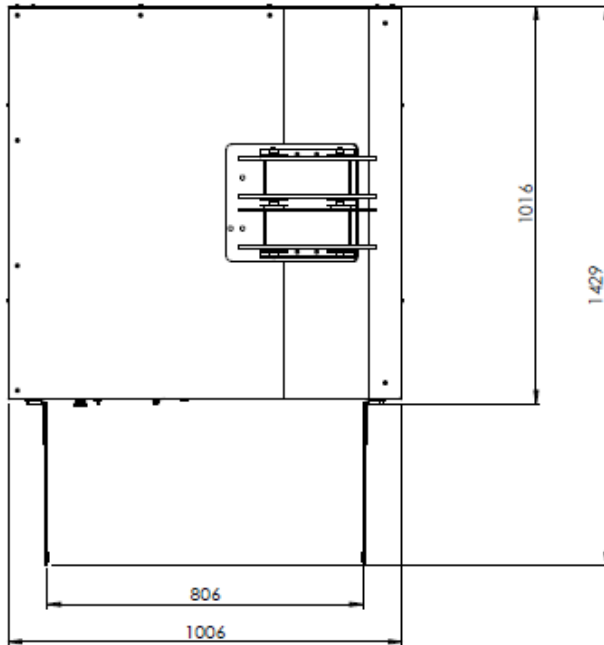
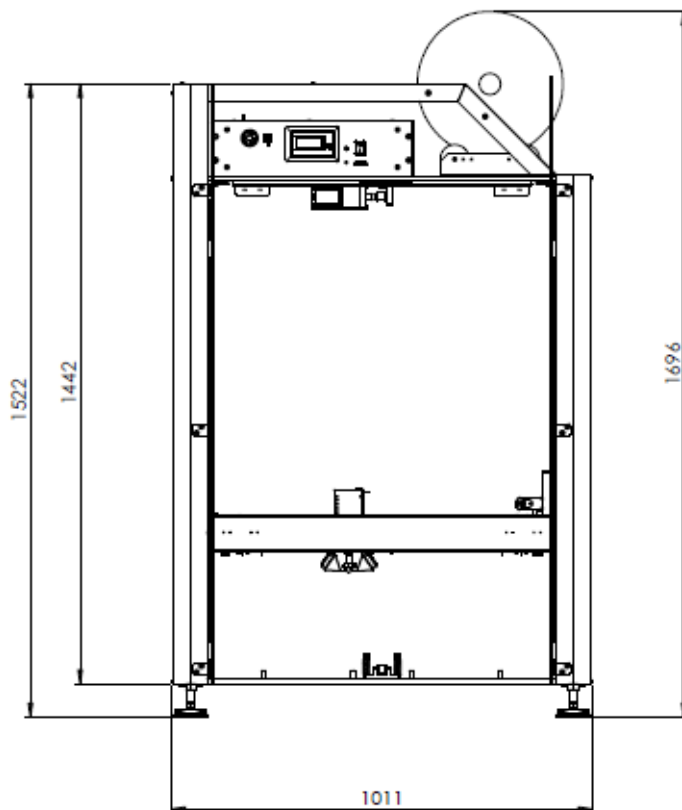
**Manual Builder Extreme 1000/1500/2000 PRO****Machine drawings****Extreme 1000 PRO - top view, door open****Extreme 1000 PRO - front view**

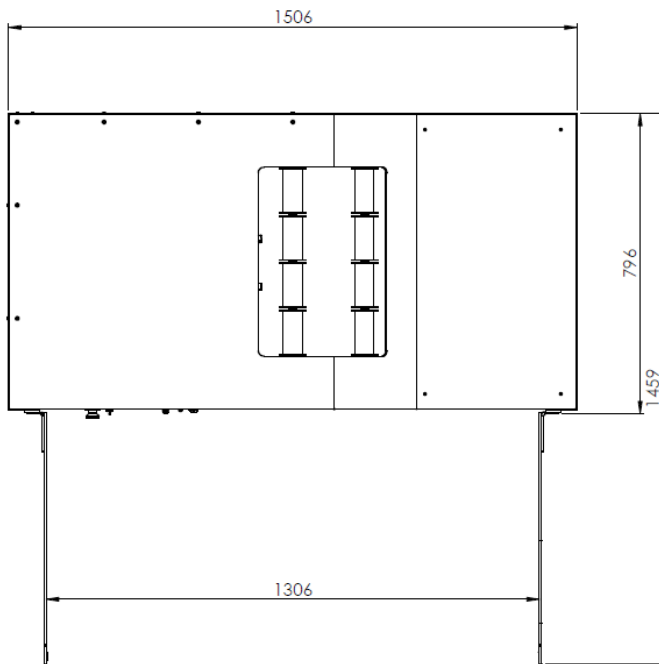
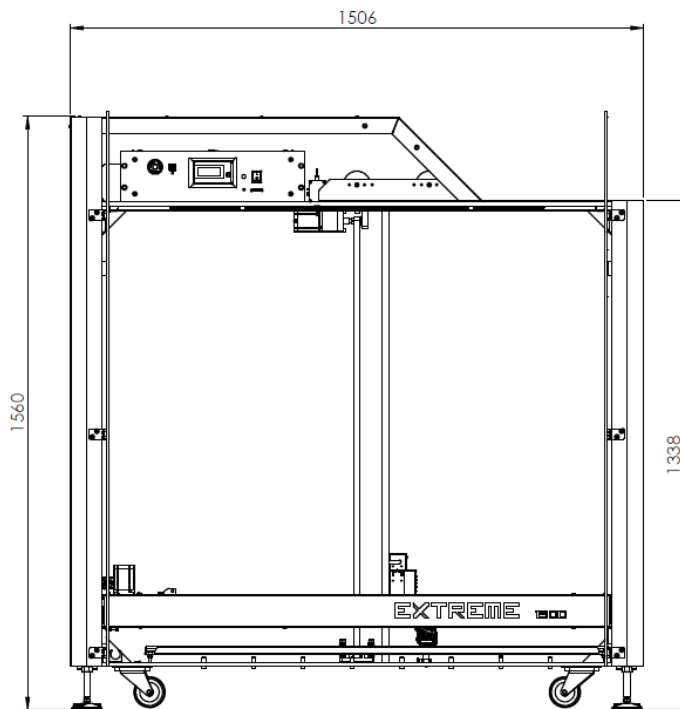
**Manual Builder Extreme 1000/1500/2000 PRO****Extreme 1500 PRO - top view, door open****Extreme 1500 PRO - front view**

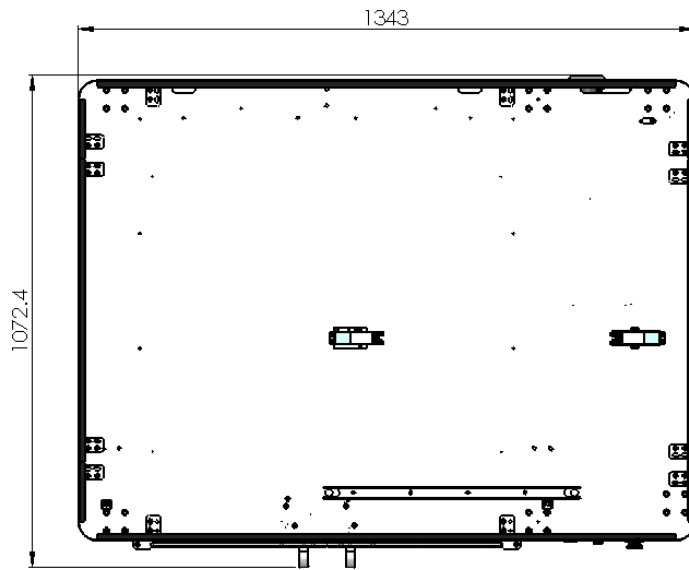
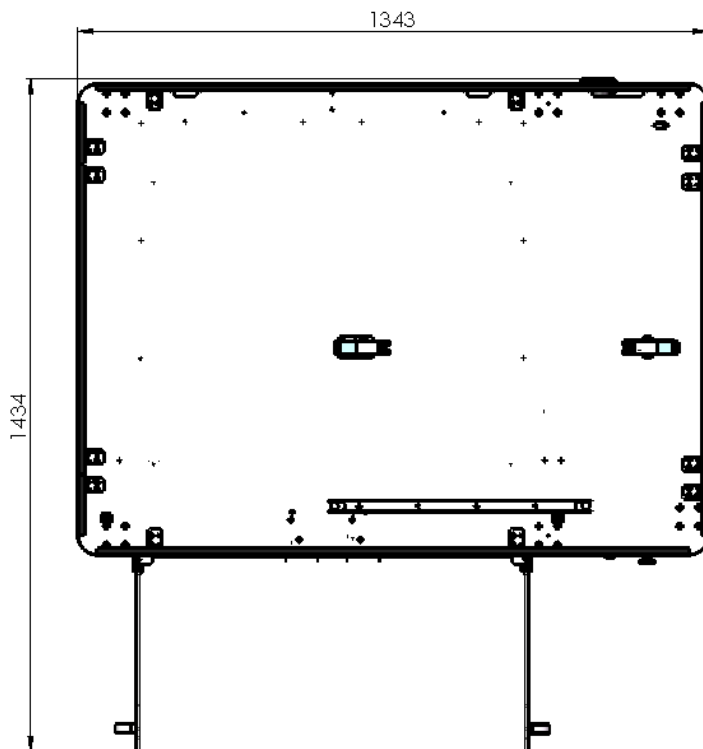
**Manual Builder Extreme 1000/1500/2000 PRO****Extreme 2000 PRO - top view****Extreme 2000 PRO - top view, door open**

**Manual Builder Extreme 1000/1500/2000 PRO****Extreme 2000 PRO - front view**